

## Duplex Filter Pi 3700

Nominal pressure 200/250/315 bar (2900/3620/4570 psi), nominal size up to 400 according DIN 24550

### 1. Features

#### High performance filters for modern hydraulic systems

- Modular system
- Compact design
- Minimal pressure drop through optimal flow design
- Visual/electrical/electronic maintenance indicator
- Threaded connections
- Change over valve on upstream side
- Ergonomic switch-over handle with safety lock and pressure compensation
- User-optimized one-hand-operation
- Equipped with highly efficient glass fibre PS filter elements
- Beta rated elements according to ISO 16889 multipass test
- Elements with high differential pressure stability and dirt holding capacity
- NPT- and SAE-connections on request
- Worldwide distribution



## 2.. Flow rate/pressure drop curve complete filter

■ 190 mm<sup>2</sup>/s  
■ 33 mm<sup>2</sup>/s

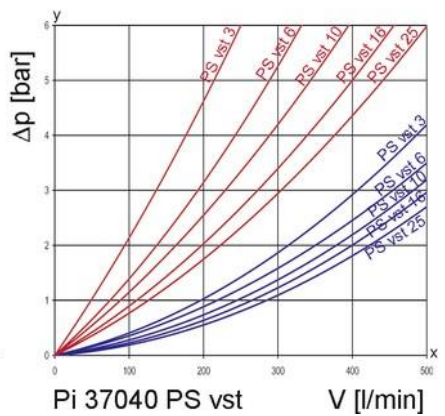
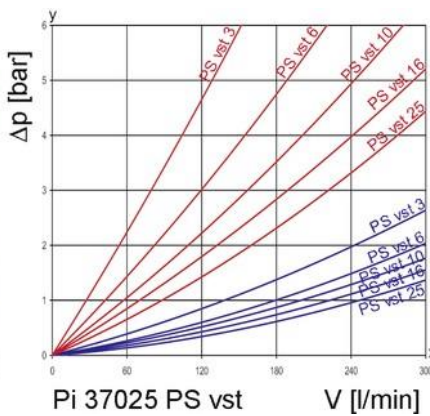
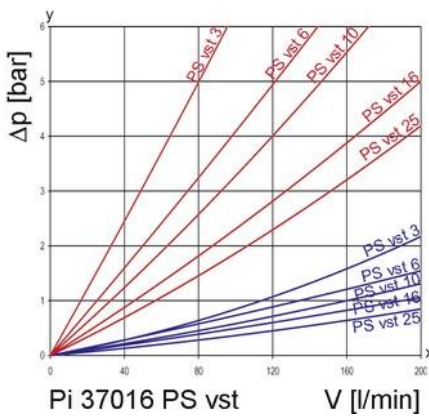
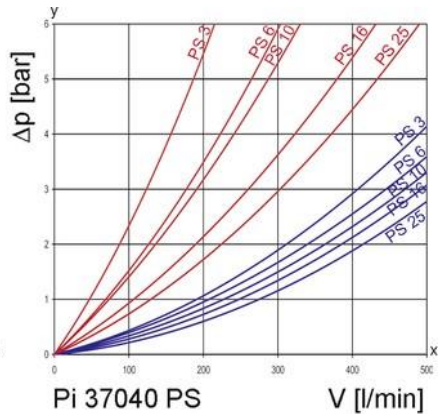
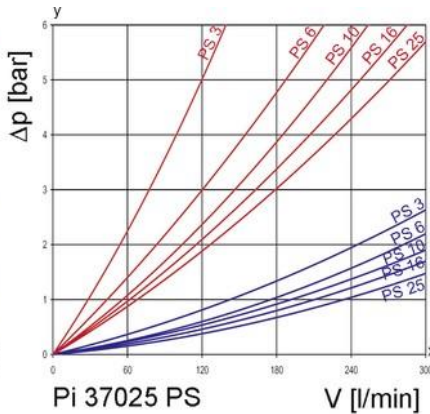
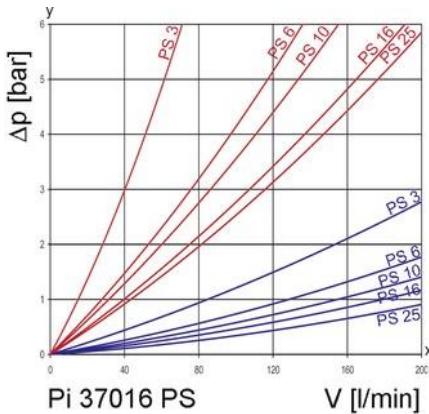
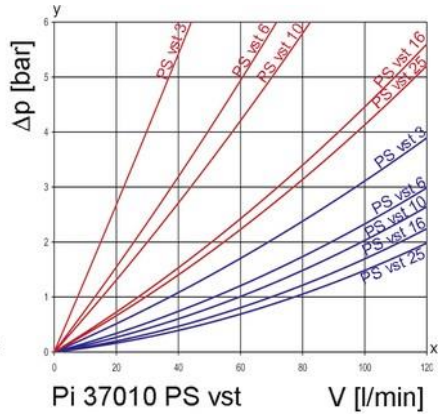
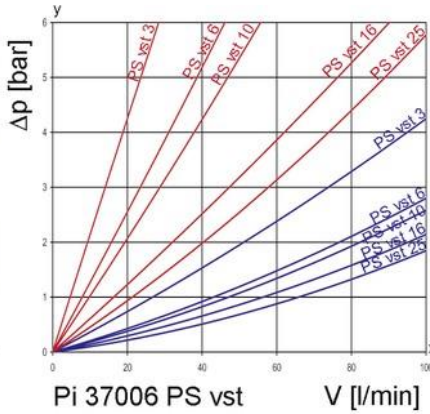
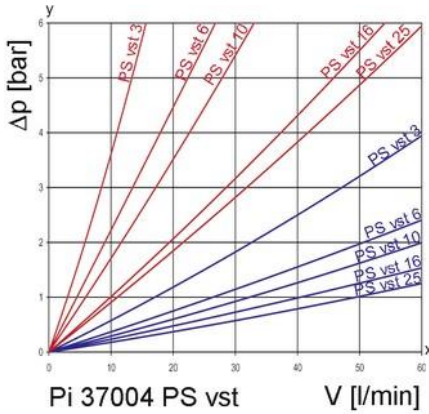
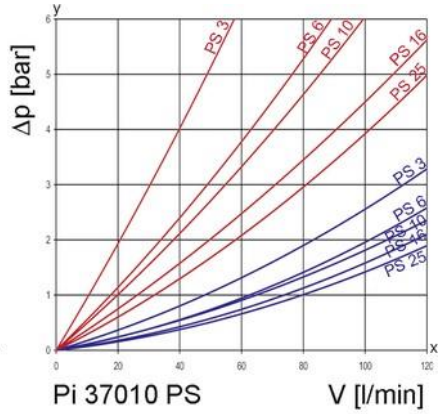
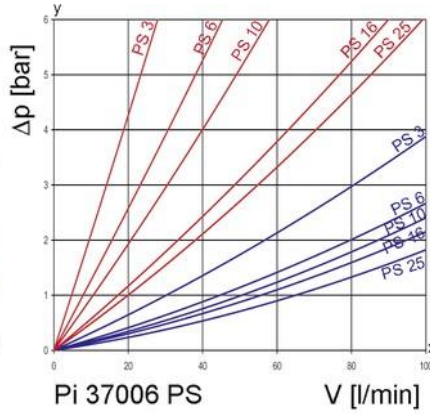
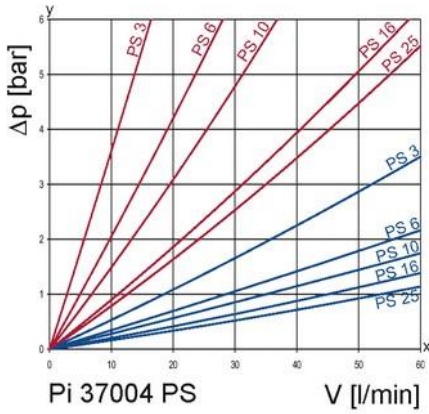

y = differential pressure  $\Delta p$  [bar]  
 x = flow rate V [l/min]

### 3. Separation grade characteristics

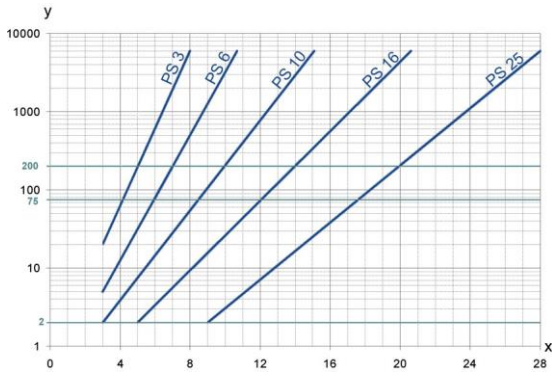

y = beta-value  
x = particle size [ $\mu\text{m}$ ]

determined by multipass tests (ISO 16889)  
calibration according to ISO 11171 (NIST)

### 5. Quality assurance

Filtration Group filters and filter elements are produced according to the following international standards:

Norm	Designation
DIN ISO 2941	Hydraulic fluid power filter elements; verification of collapse/burst resistance
DIN ISO 2942	Hydraulic fluid power filter elements; verification of fabrication integrity
DIN ISO 2943	Hydraulic fluid power filter elements; verification of material compatibility with fluids
DIN ISO 3723	Hydraulic fluid power filter elements; method for end load test
DIN ISO 3724	Hydraulic fluid power filter elements; verification of flow fatigue characteristics
ISO 3968	Hydraulic fluid power filters; evaluation of pressure drop versus flow characteristics
ISO 10771.1	Fatigue pressure testing of metal containing envelopes in hydraulic fluid applications
ISO 16889	Hydraulic fluid power filters; multipass method for evaluation filtration performance of a filter element

### 6. Symbols

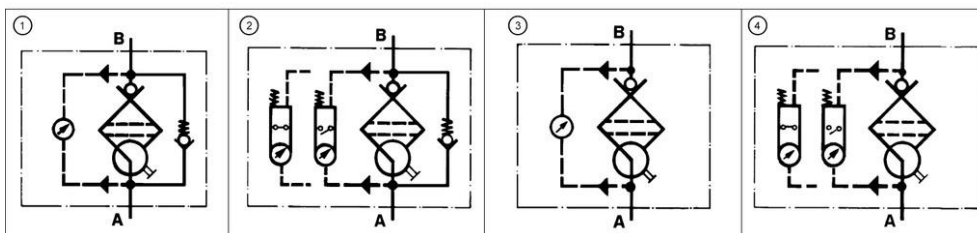

### 4. Filter performance data

tested according to ISO 16889 (multipass test)

PS elements with  
max.  $\Delta p$  20 bar

PS	3	$\beta_{5(C)} \geq 200$
PS	6	$\beta_{7(C)} \geq 200$
PS	10	$\beta_{10(C)} \geq 200$
PS	16	$\beta_{15(C)} \geq 200$
PS	25	$\beta_{20(C)} \geq 200$

values guaranteed up to  
10 bar differential pressure

PS vst elements with  
max.  $\Delta p$  210 bar

PS vst	3	$\beta_{5(C)} \geq 200$
PS vst	6	$\beta_{7(C)} \geq 200$
PS vst	10	$\beta_{10(C)} \geq 200$
PS vst	16	$\beta_{15(C)} \geq 200$
PS vst	25	$\beta_{20(C)} \geq 200$

values guaranteed up to  
20 bar differential pressure

## 7. Order numbers

Example for ordering filters:

1. Filter housing	2. 2x Filter element
V = 100 l/min and electrical maintenance indicator Type: Pi 37010-015 Order number: 78208423	PS vst 3 Type: Pi 71010 DN PS vst 3 Order number: 78227480

7.1 Housing design						
Nominal size NG [l/min]	Order number	Type	① with bypass valve and visual indicator	② with bypass valve and electrical indicator	③ with visual indicator	④ with electrical indicator
40	78208290	Pi 37004-012				
	78259889	Pi 37004-013				
	78208316	Pi 37004-014				
	78208324	Pi 37004-015				
63	78208340	Pi 37006-012				
	78259897	Pi 37006-013				
	78208365	Pi 37006-014				
	78208373	Pi 37006-015				
100	78208399	Pi 37010-012				
	78259905	Pi 37010-013				
	78208415	Pi 37010-014				
	78208423	Pi 37010-015				
160	78208449	Pi 37016-012				
	78259913	Pi 37016-013				
	78208464	Pi 37016-014				
	78208472	Pi 37016-015				
250	78208498	Pi 37025-012				
	78259921	Pi 37025-013				
	78208514	Pi 37025-014				
	78259863	Pi 37025-015				
400	78208530	Pi 37040-012 FL				
	78259939	Pi 37040-013 FL				
	78208555	Pi 37040-014 FL				
	78208563	Pi 37040-015 FL				

When filter with non bypass configuration is selected the collapse pressure of the element must not be exceeded.

## 7.2 Filter elements\*

Nominal size NG [l/min]	Order number	Type	Filter material	max. $\Delta p$ [bar]	Filter surface [cm <sup>2</sup> ]
40	78260929	Pi 21004 DN PS 3 NBR	PS 3	20	475
	77960859	Pi 22004 DN PS 6 NBR	PS 6		475
	77925571	Pi 23004 DN PS 10 NBR	PS 10		475
	78260937	Pi 24004 DN PS 16 NBR	PS 16		475
	78260945	Pi 25004 DN PS 25 NBR	PS 25		475
	78216079	Pi 71004 DN PS vst 3 NBR	PS vst 3	210	445
	77960156	Pi 72004 DN PS vst 6 NBR	PS vst 6		445
	77925654	Pi 73004 DN PS vst 10 NBR	PS vst 10		445
	78216087	Pi 74004 DN PS vst 16 NBR	PS vst 16		445
	78216095	Pi 75004 DN PS vst 25 NBR	PS vst 25		445
63	78260960	Pi 21006 DN PS 3 NBR	PS 3	20	835
	77960867	Pi 22006 DN PS 6 NBR	PS 6		835
	77925589	Pi 23006 DN PS 10 NBR	PS 10		835
	78260978	Pi 24006 DN PS 16 NBR	PS 16		835
	78260986	Pi 25006 DN PS 25 NBR	PS 25		835
	78216137	Pi 71006 DN PS vst 3 NBR	PS vst 3	210	780
	77960149	Pi 72006 DN PS vst 6 NBR	PS vst 6		780
	77925662	Pi 73006 DN PS vst 10 NBR	PS vst 10		780
	78216145	Pi 74006 DN PS vst 16 NBR	PS vst 16		780
	78216152	Pi 75006 DN PS vst 25 NBR	PS vst 25		780
100	78227472	Pi 21010 DN PS 3 NBR	PS 3	20	1375
	77960875	Pi 22010 DN PS 6 NBR	PS 6		1375
	77925597	Pi 23010 DN PS 10 NBR	PS 10		1375
	78261000	Pi 24010 DN PS 16 NBR	PS 16		1375
	78261018	Pi 25010 DN PS 25 NBR	PS 25		1375
	78227480	Pi 71010 DN PS vst 3 NBR	PS vst 3	210	1275
	77960131	Pi 72010 DN PS vst 6 NBR	PS vst 6		1275
	77925670	Pi 73010 DN PS vst 10 NBR	PS vst 10		1275
	78261281	Pi 74010 DN PS vst 16 NBR	PS vst 16		1275
	78216160	Pi 75010 DN PS vst 25 NBR	PS vst 25		1275

\*a wider range of element types is available on request

## 7.2 Filter elements\*

Nominal size NG [l/min]	Order number	Type	Filter material	max. $\Delta p$ [bar]	Filter surface [cm <sup>2</sup> ]
160	78261034	Pi 21016 DN PS 3 NBR	PS 3	20	2530
	77960826	Pi 22016 DN PS 6 NBR	PS 6		2530
	77925605	Pi 23016 DN PS 10 NBR	PS 10		2530
	78261042	Pi 24016 DN PS 16 NBR	PS 16		2530
	78261059	Pi 25016 DN PS 25 NBR	PS 25		2530
	77940638	Pi 71016 DN PS vst 3 NBR	PS vst 3	210	1885
	77960123	Pi 72016 DN PS vst 6 NBR	PS vst 6		1885
	77925688	Pi 73016 DN PS vst 10 NBR	PS vst 10		1885
	78269797	Pi 74016 DN PS vst 16 NBR	PS vst 16		1885
	78216178	Pi 75016 DN PS vst 25 NBR	PS vst 25		1885
250	78227514	Pi 21025 DN PS 3 NBR	PS 3	20	4020
	77960834	Pi 22025 DN PS 6 NBR	PS 6		4020
	77925613	Pi 23025 DN PS 10 NBR	PS 10		4020
	78261075	Pi 24025 DN PS 16 NBR	PS 16		4020
	78261083	Pi 25025 DN PS 25 NBR	PS 25		4020
	77940646	Pi 71025 DN PS vst 3 NBR	PS vst 3	210	3090
	77960115	Pi 72025 DN PS vst 6 NBR	PS vst 6		3090
	77925696	Pi 73025 DN PS vst 10 NBR	PS vst 10		3090
	78269813	Pi 74025 DN PS vst 16 NBR	PS vst 16		3090
	78216186	Pi 75025 DN PS vst 25 NBR	PS vst 25		3090
400	78227522	Pi 21 040 DN PS 3 NBR	PS 3	20	6770
	77960842	Pi 22 040 DN PS 6 NBR	PS 6		6770
	77925621	Pi 23 040 DN PS 10 NBR	PS 10		6770
	78261109	Pi 24 040 DN PS 16 NBR	PS 16		6770
	78261117	Pi 25 040 DN PS 25 NBR	PS 25		6770
	77940653	Pi 71 040 DN PS vst 3 NBR	PS vst 3	210	5240
	77960107	Pi 72 040 DN PS vst 6 NBR	PS vst 6		5240
	77930829	Pi 73 040 DN PS vst 10 NBR	PS vst 10		5240
	78269821	Pi 74 040 DN PS vst 16 NBR	PS vst 16		5240
	78260903	Pi 75 040 DN PS vst 25 NBR	PS vst 25		5240

\* a wider range of element types is available on request

## 8. Technical specifications

Design:	line mounting filter
Nominal: Pi 37004-37010	10 <sup>^</sup> 7 load changes 250 bar (3620 psi)
	10 <sup>^</sup> 6 load changes 315 bar (4570 psi)
Pi 37016-37040	2x 10 <sup>^</sup> 6 load changes 200 bar (2900 psi)
Test pressure: Pi 37004-37010	450 bar (6520 psi)
Pi 37016-37040	260 bar (3770 psi)
Pi 37004 - Pi 37040 when use on ships operating/test pressure	200/260 bar (2900/3770 psi)
Temperature range:	-10 °C to +120 °C (other temperature ranges on request)
Bypass setting:	Δ p 7 bar ± 10 %
Filter head material:	GGG
Filter housing material:	St
Sealing material:	NBR/PTFE
Maintenance indicator setting:	Δ p 5 bar ± 10 %
Electrical data of maintenance indicator:	
Max. voltage:	250 V AC/200 V DC
Max. current:	1 A
Contact load:	70 W
Type of protection:	IP 65 in inserted and secured status
Contact:	normally open/closed
Cable sleeve:	M20x1.5

The switching function can be changed by turning the electric upper part by 180° (normally closed contact or normally open contact). The state on delivery is a normally closed contact. By inductivity in the direct current circuit the use of suitable protection circuit should be considered. Further maintenance indicator details and designs are available in the maintenance indicator data sheet.

We draw attention to the fact that all values indicated are average values which do not always occur in specific cases of application. Our products are continually being further developed. Values, dimensions and weights can change as a result of this. Our specialized department will be pleased to offer you advice.

We recommend to contact us concerning applications of our filters in areas governed by the EU Directive 94/9 EC (ATEX 95). The standard version can be used for liquids based on mineral oil (corresponding to the fluids in Group 2 of Directive 97/23 EC Article 9). If you consider to use other fluids please contact us for additional support.

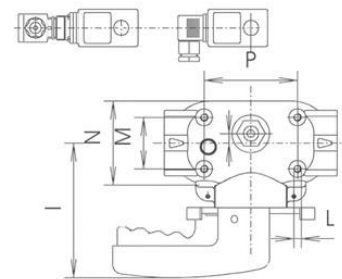
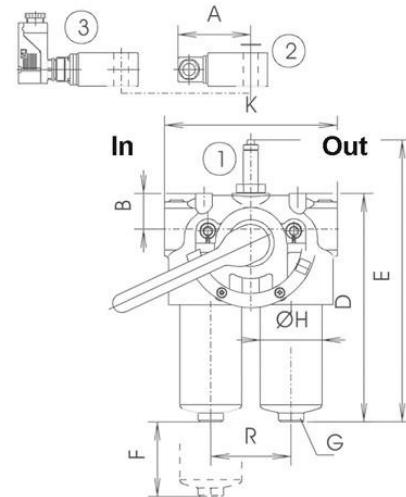

- In = inlet
- Out = outlet
- Pos. 1 Visual maintenance indicator
- Pos. 2 Electrical upper section  
Connector acc. DIN EN 175301-803  
Version: PiS 3092, 3105, 3115
- Pos. 3 Electrical upper section  
Connector acc. DIN EN 175301-804  
Version: PiS 3102, 3122, 3110
- Pos. 4 NG 250, 400 with drain plug G ¼ DIN 910

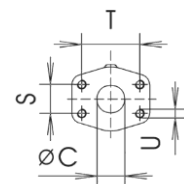

DN 38 ≥ SAE 11/2" 6000 psi flange,  
Bolts and O-rings not included in delivery

Subject to technical alteration without prior notice.

## 9. Dimensions

All dimensions except "C" in mm.

Type	A	B	C*	D	E	F	G SW	H	I	K	L	M	N	O	P	R	S	T	U	Weight [kg]
Pi 37004	78	38	G1	228	285	80	27	66	144	182	M8x15	55	90	10	100	86	-	-	-	10.5
Pi 37006	78	38	G1	288	345	80	27	66	144	182	M8x15	55	90	10	100	86	-	-	-	12.0
Pi 37010	78	38	G1	370	427	80	27	66	144	182	M8x15	55	90	10	100	86	-	-	-	14.0
Pi 37016	78	50	G1½	311	363	110	30	110	160	280	M12x18	62	140	28	210	136	-	-	-	30.0
Pi 37025	78	50	G1½	412	463	110	30	110	160	280	M12x18	62	140	28	210	136	-	-	-	35.0
Pi 37040	78	50	DN 38	562	614	110	20	110	160	280	M12x18	62	140	28	210	136	35.7	69.85	M12x20	41.0

\* SAE-connections on request

## 10. Installation, operating and maintenance instructions

### 10.1 Filter installation

When installing the filter make sure that sufficient space is available to remove filter element and filter housing. Preferably the filter should be installed with the filter housing pointing downwards. The maintenance indicator must be visible.

### 10.2 Connecting the electrical maintenance indicator

The electrical indicator is connected via a 2-pole appliance plug according to DIN EN 175301-803 with poles marked 1 and 2. The electrical section can be inverted to change from normally open to normally closed position or vice versa.

### 10.3 When should the filter element be replaced?

1. Filters equipped with visual and electrical maintenance indicator:  
During cold starts, the indicator may give a warning signal. Press the red button of the visual indicator once again only after operating temperature has been reached. If the red button immediately pops up again and/or the electrical signal has not switched off after reaching operating temperature the filter element must be replaced after the end of the shift.
2. Please always ensure that you have original Filtration Group spare elements in stock: Disposable elements (PS) cannot be cleaned.

### 10.4 Element replacement

**Note:** Elements may only be replaced by people who are familiar with the function of the filter. When replacing elements, appropriate safety clothing (protective goggles, gloves, safety shoes) must be worn.

**Note:** The maintenance indicator monitors the filter side in operation, which is identified by the position of the switching lever catch. The change-over transfer valve must be switched prior filter servicing. Now the signal of the maintenance indicators cancelled and the red button can be repressed again.

1. Operate and hold pressure equalizing lever located behind switching lever. Pull catch knob and swivel switching lever. Engage the catch on the clear filter side. Place through or drip pan underneath to collect leaving oil.
2. Loosen vent screw of the filter side not in use by 2-3 turns; max. until contact is made with the safety stop.
3. Unscrew filter housing by turning counter-clockwise. Clean the housing using a suitable cleaning solvent.  
**Warning: The shift lever may not, from now until the screwing back in of the filter housing (7.), be activated under any circumstances!**
4. Remove filter element by pulling down carefully.
5. Check o-ring on the filter housing for damage. Replace, if necessary.
6. Make sure that the order number on the spare element corresponds to the order number of the filter name-plate.  
To ensure no contamination occurs during the exchange of the element first open the plastic bag and push the element over the spigot in the filter head. Now remove plastic bag.
7. Lightly lubricate the threads of the filter housing and screw into the filter head. Maximum tightening torque for NG 40 to 100 = 60 Nm, for NG 160 to 400 = 100 Nm.
8. To refill the filter chamber, operate only the pressure equalizing lever (leave the switching lever arrested in its catch) long enough for the medium to emerge bubble-free from the vent bore.
9. Tighten vent screw. Check filter for leaks by operating the pressure equalizing lever once again.



## 11. Spare parts list

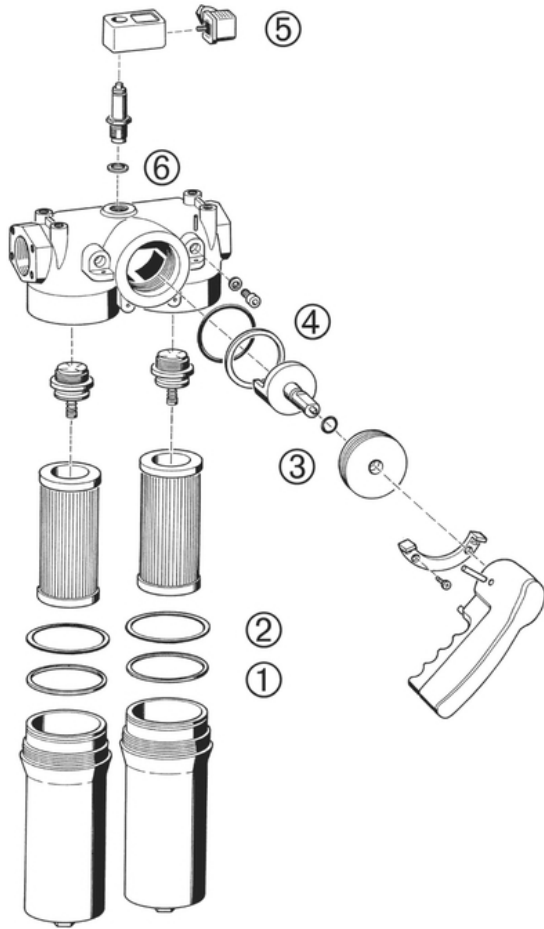

Order numbers for spare parts		
Position	Type	Order numbers
① bis ④	Seal kit	
	<b>Pi 37004 - Pi 37010</b>	
	NBR	79322009
	FPM	79322017
	EPDM	79322025
	<b>Pi 37016 - Pi 37040</b>	
	NBR	79375213
	FPM	79375221
	EPDM	79375239
⑤	Maintenance indicator	
	Visual PiS 3093/5	77669914
	Electrical PiS 3092/5	77669864
	Electrical upper section only	77536550
⑥	Seal kit for maintenance indicator	
	NBR	77760275
	FPM	77760283
	EPDM	77760291

Filtration Group GmbH  
Schleifbachweg 45  
D-74613 Öhringen  
Phone +49 7941 6466-0  
Fax +49 7941 6466-429  
fm.de.sales@filtrationgroup.com  
www.fluid.filtrationgroup.com  
78368631.06/2019  
[Duplex Filter Pi 3700 up to NG 400](#)